

## RMN

Reduktioner presset

### Beskrivelse

Kort centrisk reduktion mufte-nippel leveres i galvaniseret stål i dimensionerne Ø100-Ø400mm

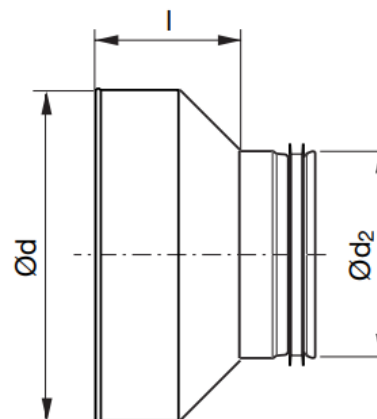

Ød <sub>1</sub> nom [mm]	Ød <sub>2</sub> nom [mm]	l [mm]	M [kg]
100	80	56	0,13
125	80	65	0,18
125	100	59	0,15
160	80	96	0,18
160	100	74	0,25
160	125	64	0,22
200	100	100	0,33
200	125	78	0,34
200	160	59	0,27
250	125	115	0,49
250	160	93	0,45
250	200	64	0,36
315	160	142	0,69
315	200	114	0,66
315	250	90	0,50
355	250	155	0,90
355	315	115	0,80
400	250	141	0,84
400	315	110	0,74

Bestillingseksempel:

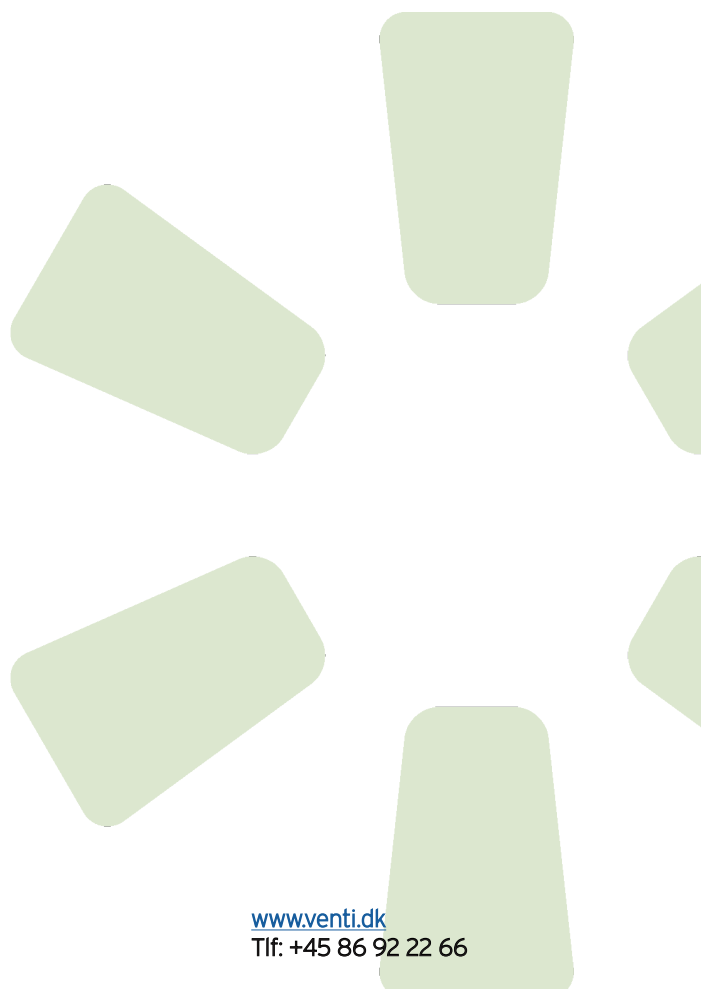
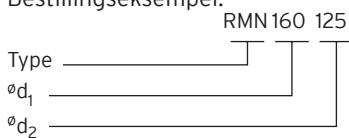

## RMN

Reduktioner presset

### 1 dimensionstrin

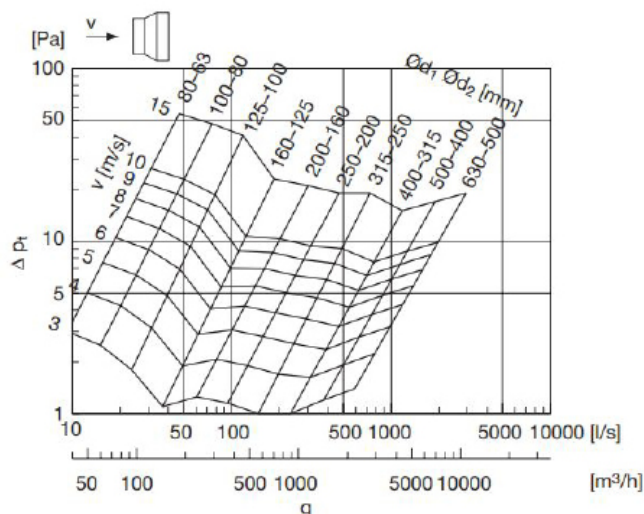
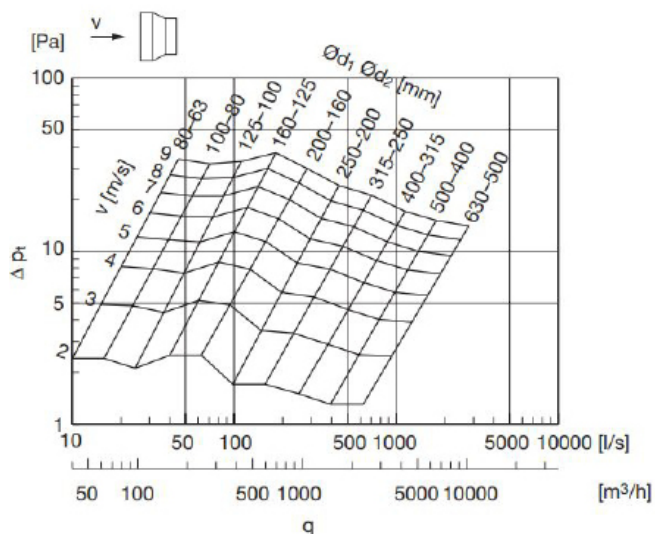

### 2 dimensionstrin

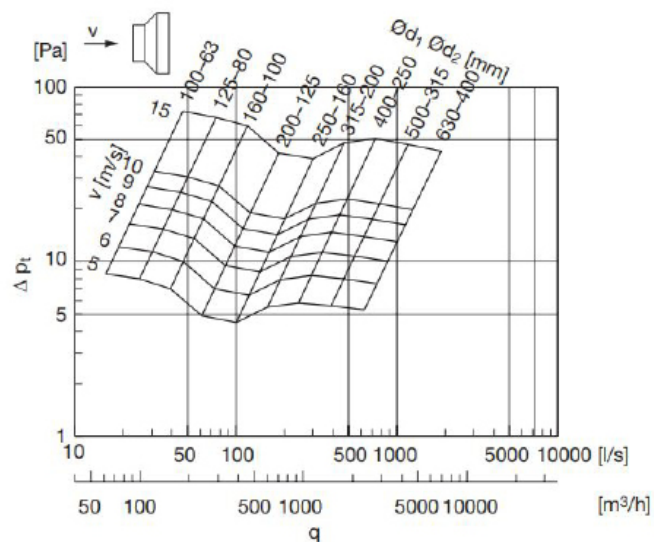
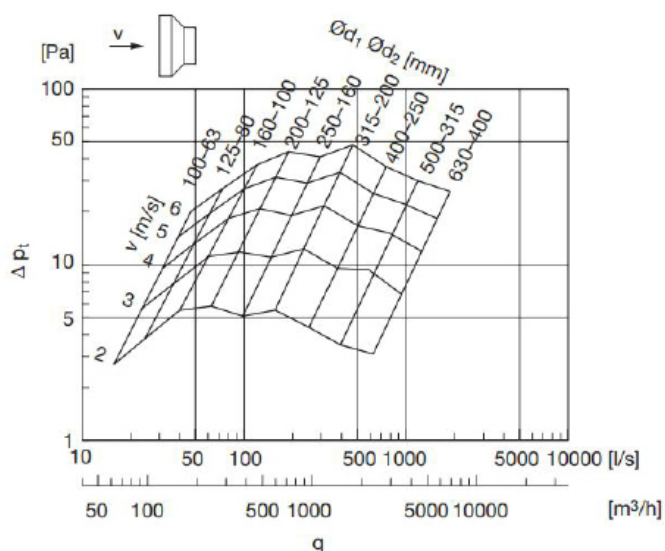

### 3 dimensionstrin

